



EGW20-E40

Thrust washer

Schaeffler ID:
0707026830000

Thrust washer, maintenance-free, material in accordance with ISO 3547-4, with steel backing



Technical information

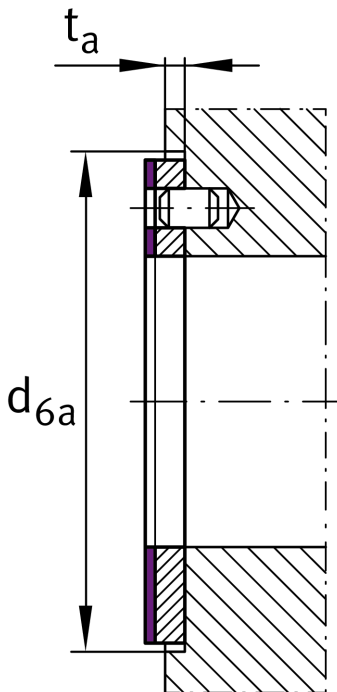
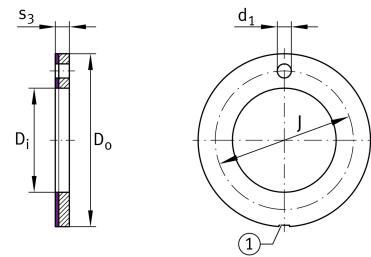

Main Dimensions & Performance Data

D_i	20 mm	Inner diameter
s_3	1.5 mm	Wall thickness
C_a	98,500 N	Basic dynamic load rating, axial
C_{0a}	176,000 N	Basic static load rating, axial
	7.7 g	Weight

Dimensions

J	28 mm	Pitch circle
d_1	3 mm	Fixing hole diameter
t_a	1 mm	Mounting dimension
d_{6a}	36 mm	Mounting dimension d_{6a}
D_{iOT}	0.25 mm	Inner diameter, upper tolerance
D_{iUT}	0 mm	Inner diameter, lower tolerance
D_o	36 mm	Outer Diameter
D_{oOT}	0 mm	Outside diameter, upper tolerance
D_{oUT}	-0.25 mm	Outside diameter, lower tolerance
s_{3OT}	0 mm	Wall thickness, upper tolerance
s_{3UT}	-0.05 mm	Wall thickness, lower tolerance
J_{OT}	0.12 mm	Pitch circle, upper tolerance
J_{UT}	-0.12 mm	Pitch circle, lower tolerance
d_{1OT}	0.4 mm	Fixing hole diameter, upper tolerance
d_{1UT}	0.1 mm	Fixing hole diameter, lower tolerance
t_{aOT}	0.2 mm	Mounting dimension, upper tolerance
t_{aUT}	-0.2 mm	Mounting dimension, lower tolerance
d_{6aOT}	0.12 mm	Mounting dimension d_{6a} , upper tolerance
d_{6aUT}	-0.12 mm	Mounting dimension d_{6a} , lower tolerance

Temperature range

T _{min}	-200 °C	Operating temperature min.
T _{max}	280 °C	Operating temperature max.